

# JVC



## MICRO COMPONENT SYSTEM

微型组合音响

# UX-V6V

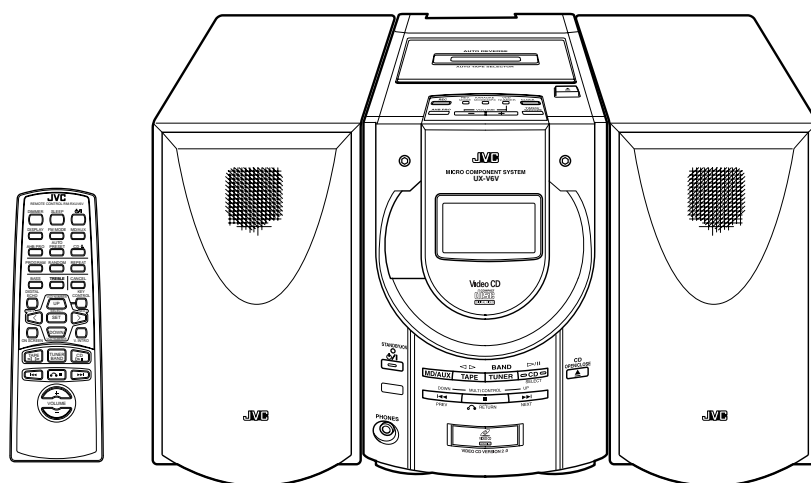

PlayBack Control



## INSTRUCTIONS

使用说明书

### For Customer Use:

Enter below the Model No. and Serial No. which are located either on the rear, bottom or side of the cabinet. Retain this information for future reference.

Model No. \_\_\_\_\_

Serial No. \_\_\_\_\_

LVT0352-001A  
[U/UB/US/UX]

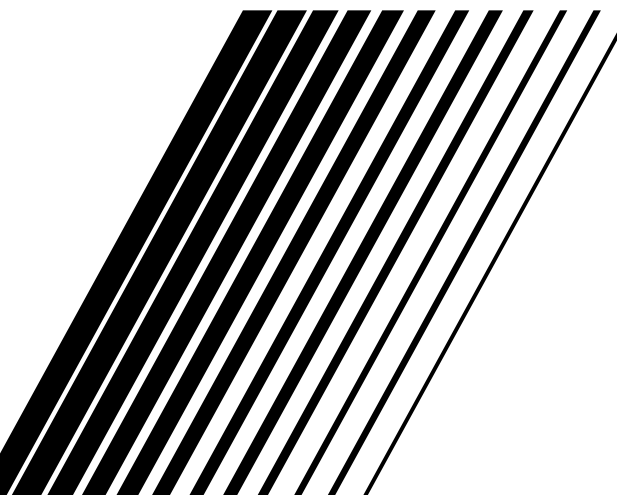

## Warnings, Cautions and Others 警告，注意及其他须知事项

### CAUTION

To reduce the risk of electrical shocks, fire, etc.:

1. Do not remove screws, covers or cabinet.
2. Do not expose this appliance to rain or moisture.

### 注意

为了减低触电，火灾等危险：

1. 请勿擅自卸下螺丝钉，盖子或机壳。
2. 切勿让本机受雨淋或置潮湿环境中。

### Caution — ⏻/I switch!

Disconnect the mains plug to shut the power off completely. The ⏻/I switch in any position does not disconnect the mains line. The power can be remote controlled.

### 注意 —— ⏻/I 开关！

无论 ⏻/I 开关在任何位置，电源线的电源还是没有被切断，若要电源完全关闭，应把电源插头拔离插座。电源开关可用遥控器控制。

## IMPORTANT FOR LASER PRODUCTS / 雷射产品的重要说明

### REPRODUCTION OF LABELS / 标签内容说明

① CLASSIFICATION LABEL, PLACED ON EXTERIOR SURFACE

① 分类标签，贴在外部表面。

② WARNING LABEL, PLACED INSIDE THE UNIT

② 警告标签，贴于机内。

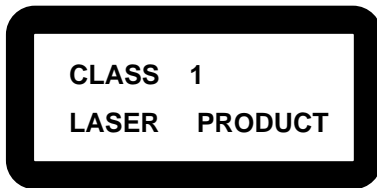

**DANGER:** Invisible laser radiation when open and interlock failed or defeated. AVOID DIRECT EXPOSURE TO BEAM. (e)

**WARNING:** Osynlig laserstrålning när denna del är öppnad och spärren är urkopplad. Betrakta ej strålen. (s)

**ADVARSEL:** Usynlig laserstrålning ved åbning, når sikkerhedsafbrydere er ude af funktion. Undgå udsættelse for stråling (d)

**VARO:** Avattaessa ja suo-jalukitus ohitettaessa olet alttiina näkymättömälle lasersäteilylle. Älä katso säteeseen. (f)

1. CLASS 1 LASER PRODUCT
2. **DANGER:** Invisible laser radiation when open and interlock failed or defeated. Avoid direct exposure to beam.
3. **CAUTION:** Do not open the top cover. There are no user serviceable parts inside the Unit; leave all servicing to qualified service personnel.

1. 一级雷射产品。
2. **危险：**当内部锁定装置失效或损坏后，打开盖板可能会产生不可见的雷射辐射。应避免受到光束直接照射。
3. **注意：**请勿打开顶盖板。本机内部没有用户可自行维修的部件；所有维修工作应由有资格的人员完成。

### Caution: Proper Ventilation

To avoid risk of electric shock and fire, and to prevent damage, locate the apparatus as follows:

- 1 Front: No obstructions and open spacing.
- 2 Sides/ Top/ Back: No obstructions should be placed in the areas shown by the dimensions below.
- 3 Bottom: Place on the level surface. Maintain an adequate air path for ventilation by placing on a stand with a height of 10 cm or more.

### 告诫：正确通风

为免发生触电和火警的危险，及防止本机受损，请将本机如下放置：

1. 前面：没有障碍物及地方开关。
2. 侧面／顶部／背面：在图中所示范围中，不应放置任何障碍物。
3. 底部：放置在水面上。放置在一个高10厘米或以上的台上，以保持足够的通风通道。

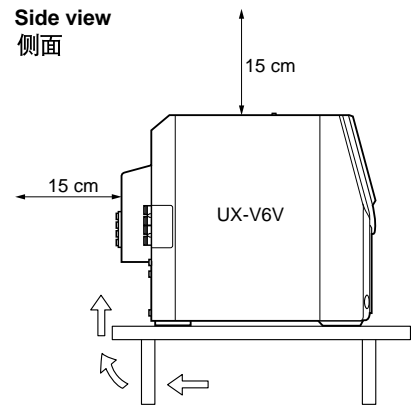
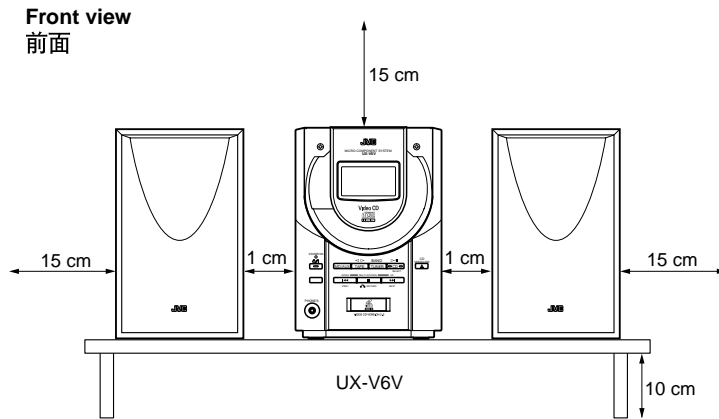

Thank you for purchasing the JVC Micro Component System.  
 We hope it will be a valued addition to your home, giving you years of enjoyment.  
 Be sure to read this instruction manual carefully before operating your new stereo system.  
 In it you will find all the information you need to set up and use the system.  
 If you have any questions about your System not answered in this manual, please contact your dealer.

## Features

Here are some of the things that make your System both powerful and easy to use.

- **Types of CD you can play**  
 Many types of compact discs are sold for a variety of uses. The Video CD Player can play the following compact discs.
  - **Video CD without Playback Control function:** for audio and video (moving picture) reproduction, including multiplex sound.
  - **Video CD with Playback Control function:** featuring menu-type operation and super-fine still pictures for audio and video (moving picture) reproduction, including multiplex sound.
  - **CD Graphics (CD-G):** for audio and video (still picture) reproduction, including multiplex sound.
  - **Digital Audio CD, including single CDs:** for audio reproduction
- **CDs you cannot play:** Do not play CD-ROMs on this System. Doing so may generate a noise which can damage your speakers.
- JVC's **COMPU PLAY** feature that, with a single touch, automatically starts playing the radio, Cassette Deck or CD Player.
- The System incorporates Active Hyper Bass PRO circuitry to faithfully reproduce low frequency sounds.
- A 45-station preset capability (15 stations each for FM, AM and SW) in addition to auto-seek and manual tuning.
- Versatile CD options include repeat, random and program play.
- Timer functions; Daily Timer and Sleep Timer.
- Auto-reverse tape function.
- You can use audio CDs for Karaoke with the voice masking system. When you use video CDs or CD-Gs, you can replace the lead vocal on your favourite songs with your own.
  - Digital Echo applied to your voice through the microphone gives you a professional sound.



## How This Manual Is Organized

- Basic information that is the same for many different functions - e.g. setting the volume - is given in the section 'Basic Operations', and not repeated under each function.
- The names of buttons/controls and display messages are written in all capital letters: e.g. TUNER BAND, "NO DISC".
- System functions are written with an initial capital letter only: e.g. Normal Play.

Use the table of contents to look up specific information you require.

We've enjoyed making this manual for you, and hope it serves you in enjoying the many features built into your System.

## IMPORTANT CAUTIONS

### 1. Installation of the System

- Select a place which is level, dry and neither too hot nor too cold. (Between 5°C and 35°C or 41°F and 95°F.)
- Do not place the System too close to a TV because this may cause interference to both products.
- Do not use the System where there may be vibrations.

### 2. Power cord

- Do not handle the power cord with wet hands!
- Some power is always consumed as long as the power cord is connected to the wall outlet.
- When unplugging the System from the wall outlet, always pull the plug, not the power cord.

### 3. Malfunctions, etc.

- There are no user serviceable parts inside. If there is a problem with your System, unplug the power cord and ask your dealer.
- Do not put any metallic objects or tools into the System.

# Table of Contents

Features .....	1	Using the Cassette Deck (Recording) .....	17
How This Manual Is Organized .....	1	Using External Equipment.....	19
IMPORTANT CAUTIONS .....	1	Using the Timers .....	20
<b>Getting Started .....</b>	<b>2</b>	Using the Microphone.....	22
<b>Basic Operations .....</b>	<b>6</b>	Care And Maintenance .....	24
<b>Using the Tuner .....</b>	<b>8</b>	Troubleshooting .....	25
<b>Using the CD Player (Audio CDs) .....</b>	<b>10</b>	Specifications .....	26
<b>Using the Video CD Player (Video CDs, CD-Gs) ..</b>	<b>12</b>		
<b>Using the Cassette Deck (Listening to a Tape) ....</b>	<b>16</b>		

# Getting Started

## Accessories

As you unpack your new System, please check to make sure that along with the System the following items are included:

- Power Cord (1)
- AM/SW Loop Antenna (1)
- FM/SW Wire Antenna (1)
- Video Cord (1)
- Remote Control (1)
- Batteries (2)
- AC Plug Adaptor (except for Hong Kong) (1)

If any of these items is missing, contact your dealer immediately.

## Set the VOLTAGE SELECTOR Switch

To avoid damaging the System, set the voltage before plugging in the System.

Set the correct voltage for your area with the VOLTAGE SELECTOR switch on the back of the Unit. Use a screwdriver to rotate the selector so the number the arrow is pointed at is the same as the voltage.

### VOLTAGE SELECTOR

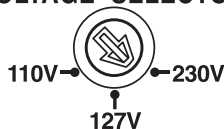

## Putting Batteries in the Remote Control

Load the batteries as indicated in the illustration, making sure that they are positioned correctly (+ with + and – with –).

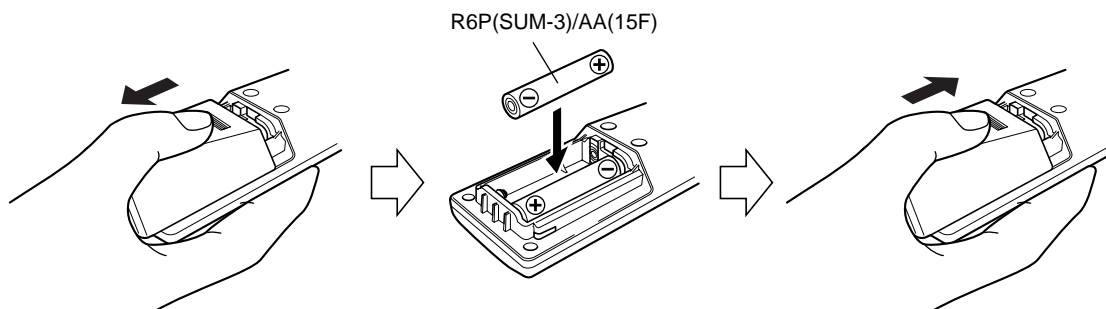

### CAUTION: To avoid battery leakage or explosion:

- Remove batteries when the Remote Control will not be used for a long time.
- When you need to replace the batteries, replace both batteries. Do not use an old battery with a new one.
- Do not use different types of batteries together.

## Using the Remote Control

The Remote Control makes it easy to use many of the functions of the System from a distance of up to 7m (23 feet) away. You need to point the Remote Control at the remote sensor on the System's front panel.

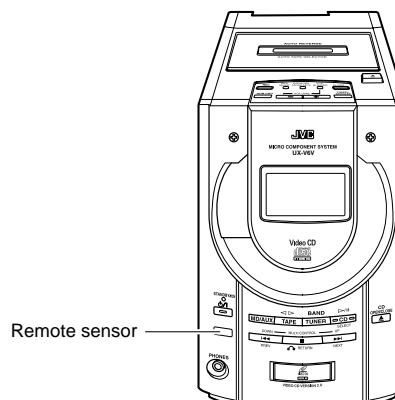

**CAUTION: Make all connections before plugging the Unit into an AC power outlet.**

## Connecting the FM/SW Antenna

### Using the Supplied Wire Antenna

#### Rear Panel of the Unit

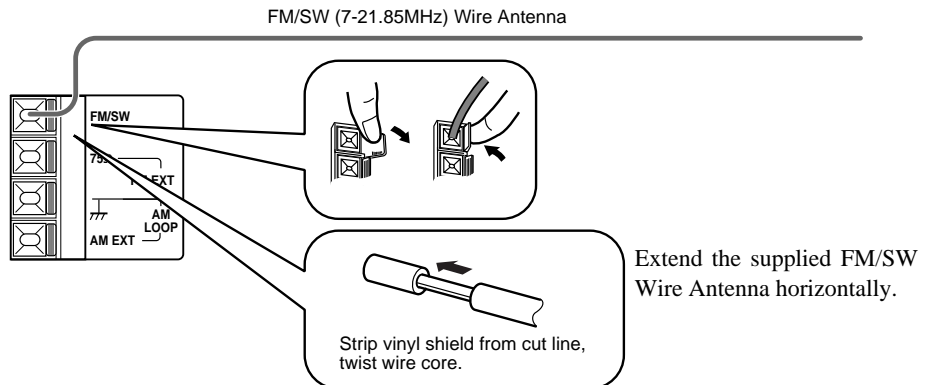
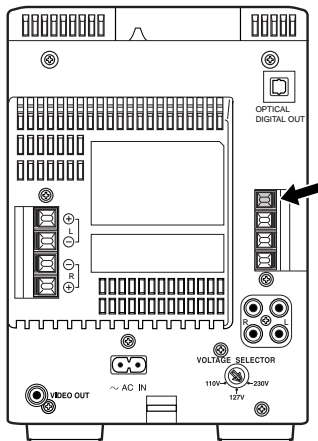

### Using an FM 75-Ohm Antenna Wire (not Supplied) and SW (7-21.85 MHz) Antenna Wire (not Supplied)

If reception is poor, connect the outdoor antenna.

#### Rear Panel of the Unit

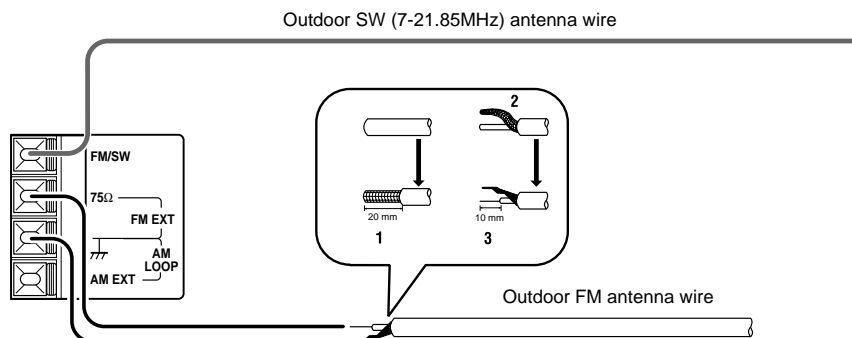
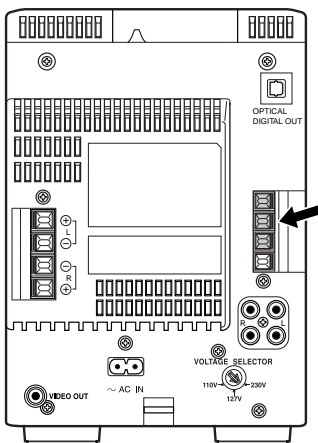

**Note:** Before attaching a 75 ohm coaxial lead (the kind with a round wire going to an outdoor antenna) or an outdoor SW antenna, disconnect the supplied FM/SW Wire Antenna.

## Connecting the AM/SW Antenna

#### Rear Panel of the Unit

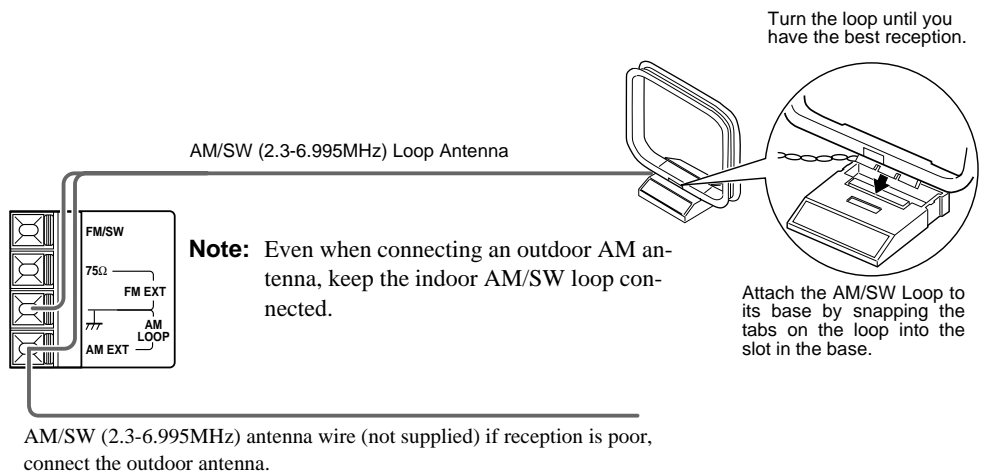
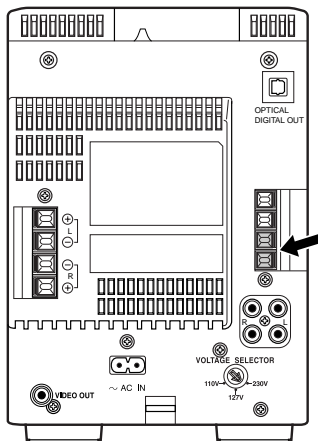

**CAUTION: To avoid noise, keep antennas away from the System, the connecting cord and the AC power cord.**



**CAUTION: Make all connections before plugging the System into an AC power outlet.**

## Connecting an MD Recorder, etc (Digital Output)

Unplug the cap and connect an optical digital cord (not supplied) between the System's OPTICAL DIGITAL OUT terminal and the input terminal of the MD recorder, etc.

You can now record the digital output signal from the System's CD Player to the MD recorder, etc.

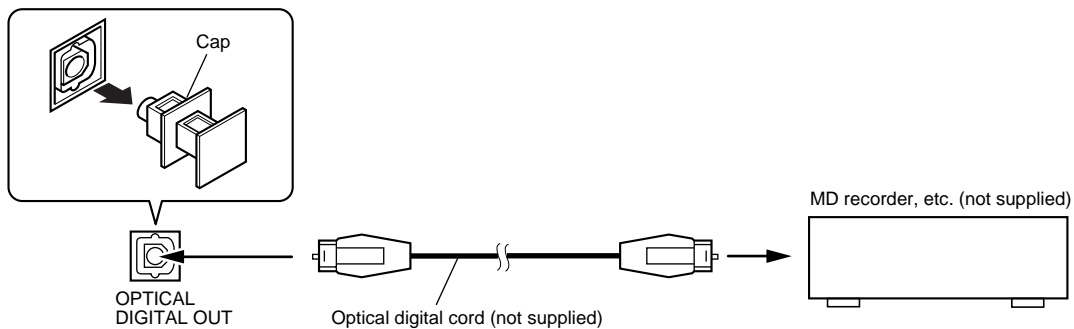

## Connecting the AC Power Cord

Firmly insert the supplied AC power cord into the AC inlet on the back of the Unit.

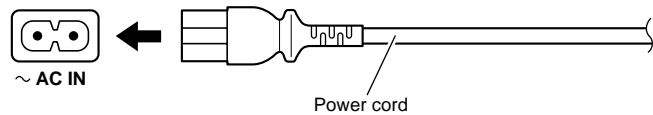

### CAUTIONS:

- **ONLY USE THE JVC POWER CORD PROVIDED WITH THIS SYSTEM TO AVOID SHOCK OR DAMAGE TO THE SYSTEM.**
- **ALWAYS UNPLUG THE POWER CORD FROM THE OUTLET WHEN YOU PLAN ON NOT USING THE SYSTEM FOR AN EXTENDED PERIOD OF TIME.**

**Now you can plug the AC power cord into the wall outlet, and your System is at your command!**

## COMPU PLAY

JVC's COMPU PLAY feature lets you control the most frequently used System functions with a single touch.

With COMPU PLAY, you can play a CD, a tape, or turn on the radio with a single press of the play button for that function.

COMPU PLAY turns the power on for you, then starts the function you have selected. If the System is not ready, for example, no CD is loaded, the System still turns on so that you can load a CD.

The COMPU PLAY buttons are:

### On the Unit

CD ▷/|| button  
TUNER BAND button  
TAPE < ▷ button  
MD/AUX button

### On the Remote Control

CD ▷/|| button  
TUNER BAND button  
TAPE < ▷ button  
MD/AUX button

## AUTOMATIC POWER ON

The System automatically turns on with the following operation.

- When you press the CD ▲ button, the System automatically turns on and the CD cover opens to allow CD insertion. However, this operation does not change the function to CD.  
When you press the ⏻ button to turn off the System, the CD cover will automatically closed if it is open.



# Basic Operations

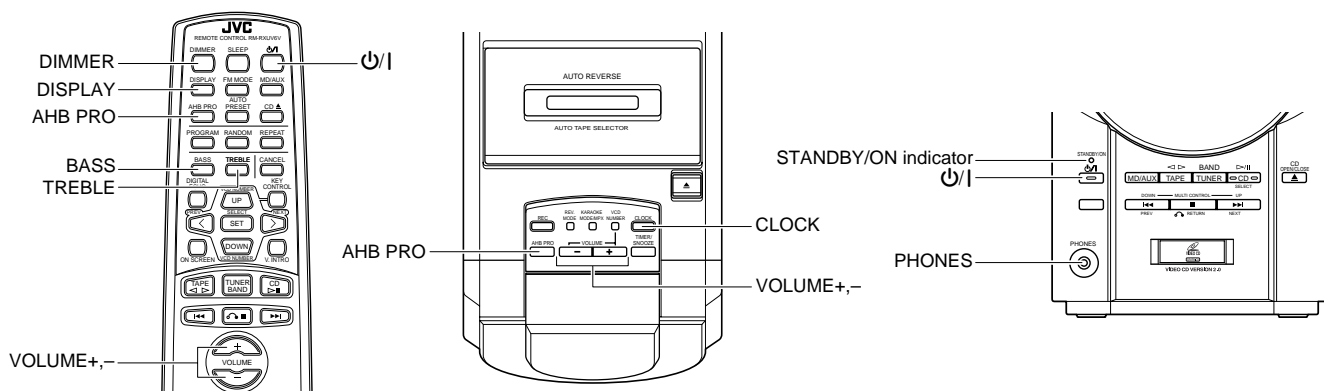

## Turning the Power On and Off

### To Turn the Power On

#### Press the $\text{O/I}$ button.

The display comes on and "HELLO" is displayed once. The STANDBY/ON indicator lights in green.

The System always comes on ready to continue in the mode it was in when the power was last turned off.

- For example, if the last thing you were doing was listening to a CD, you are now ready to listen to a CD again.
- If you were listening to the Tuner last, the Tuner comes on playing the station it was last set to.

### To Turn the Power Off

#### Press the $\text{O/I}$ button again.

You will see "GOOD BYE" displayed and the display goes out, except for the clock display. The STANDBY/ON indicator lights in red.

- Some power is always consumed even though power is turned off (called Standby Mode).
- To switch off the System completely, unplug the AC power cord from the wall outlet. You will need to reset the clock after about 20 minutes after unplugging System.

## Adjusting the Brightness (DIMMER)

You can adjust the brightness of the display.

### When the System is Turned On

**To dim brightness,** press the DIMMER button on the Remote Control.

**To turn up the brightness,** press the DIMMER button on the Remote Control again.

### When the System is Turned Off (STANDBY MODE)

**To turn on the backlighting,** press the DIMMER button on the Remote Control. The brightness is the same as for darker one mentioned above.

**To turn off the backlighting,** press the DIMMER button on the Remote Control again.

## Adjusting the Volume

Press the VOLUME + button to increase the volume or press the VOLUME - button to decrease it.



You can adjust the volume level between 0 and 50.

**CAUTION: DO NOT turn on the System and/or start playing any source without first setting the VOLUME control to minimum, as a sudden blast of sound could damage your hearing, speakers and/or headphones.**

### For private listening

Connect a pair of headphones to the PHONES jack. No sound comes out of the speakers.

Be sure to turn down the volume before connecting or putting on headphones.

## Boosting the Bass Sound (Active Hyper Bass PRO)

You can reinforce the bass sound to maintain rich, full bass at low volume (you can use this effect only for playback):

**To get the effect**, press the AHB (Active Hyper Bass) PRO button.

The “BASS” indicator lights up on the display.

**To cancel the effect**, press the button again.

The “BASS” indicator goes out.

## Tone Control (BASS/TREBLE)

You can control the tone by changing the bass and treble.

The analog clock acts to display the bass and treble settings.

By pressing either the BASS or TREBLE button on the **Remote Control**, you can visually see the current tone control settings.

Examples:

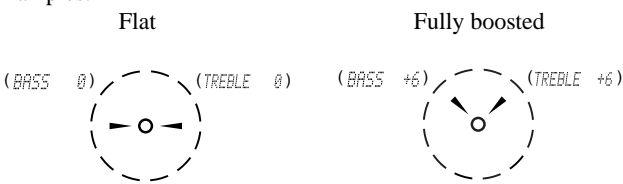

### BASS Control

You can adjust the bass level (low frequency range level) between -6 and +6. (0: Flat)

**1. Press the BASS button on the Remote Control.**

**2. Press the UP or DOWN button on the Remote Control to adjust the bass level.**

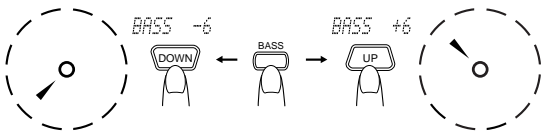

### TREBLE Control

You can adjust the treble level (high frequency range level) between -6 and +6. (0: Flat)

**1. Press the TREBLE button on the Remote Control.**

**2. Press the UP or DOWN button on the Remote Control to adjust the treble level.**

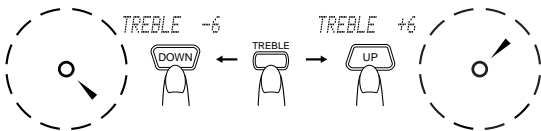

## Displaying the Time

In the System is in Standby, the digital clock and analog clock appear on the display at the same time. Only the analog clock is displayed when a music source is selected. You can see the analog clock at all times.

When the System is turned on, you can display the digital clock at any time.

**To display the digital clock**, press the CLOCK button on the Unit or DISPLAY button on the Remote Control.

**To return to the previous mode**, press the same button again.

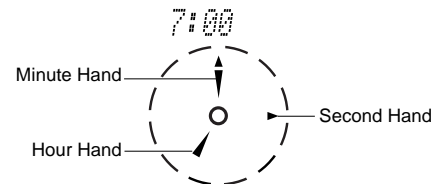

**Note:** To let the clock work, you need to set the clock beforehand. (See “Setting the Clock” on page 20.)



## Presetting Stations

You can preset up to 15 FM stations, up to 15 AM stations and up to 15 SW stations **using the Remote Control**.

**Note:** Preset numbers may have been set to factory test frequencies prior to shipment. This is not a malfunction. You can preset the stations you want into memory by following one of the presetting methods below.

### To Manually Preset Stations

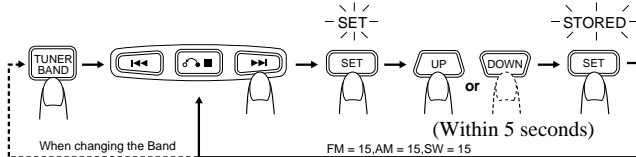

- 1. Select a band (FM, AM or SW) by pressing the TUNER BAND button.**
- 2. Press the ◀◀ or ▶▶ button to tune in a station.**
- 3. Press the SET button.**  
 "SET" will blink for 5 seconds.  
 Within 5 seconds, proceed to the next step.  
 When the display returns to the one set in step 2 after 5 seconds, press the SET button again.
- 4. Press the UP, DOWN, >, or < button within 5 seconds to select the preset number.**  
 UP or DOWN button: Increase or decrease the preset number by 1.  
 Pressing and holding the button will continuously increase or decrease the preset number.  
 > or < button: Increase or decrease the preset number by 1.  
 Pressing and holding the button will rapidly increase or decrease the preset number.
- 5. Press the SET button within 5 seconds.**  
 "STORED" appears and after 2 seconds, the display will show you the broadcast frequency.
- 6. Repeat above steps 1 to 5 for each station you want to store in memory.**

To change the preset stations, simply repeat the same steps above.

## Auto Presetting

### (Using the Remote Control)

In each band, you can automatically preset 15 stations. The System will automatically give each station a preset number, starting from the lowest frequency and moving up the frequency.

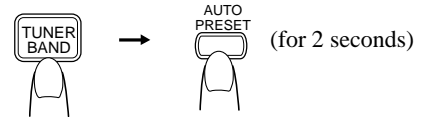

- 1. Select a band (FM, AM or SW) by pressing the TUNER BAND button.**
- 2. Press the AUTO PRESET button on the Remote Control for more than two seconds.**
- 3. Repeat steps 1-2 for the other band.**

You can change any preset station manually.

**CAUTION:** If the system is unplugged or a power failure occurs, the preset stations will be stored for about 24 hours. However, if the preset stations are erased, you will need to preset them again.

## Changing from Stereo to Mono

When you are tuned into an FM stereo broadcast, the "STEREO" indicator lights up and you can hear the station in stereo.

If an FM stereo broadcast is hard to receive or noisy, you can select Monaural mode. This may improve reception, but you will lose the stereo effect.

Press the FM MODE button on the Remote Control so that the "MONO" indicator lights up on the display.

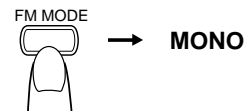

To restore the stereo effect, press the FM MODE button on the Remote Control so that the "MONO" indicator goes off.

# Using the CD Player (Audio CDs)

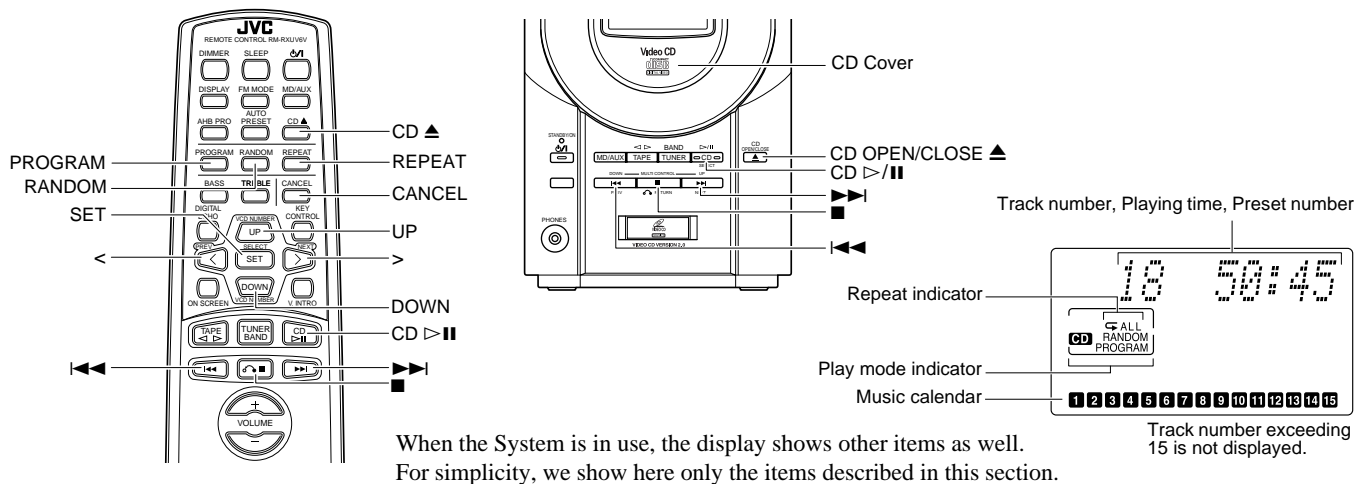

You can use Normal, Random, Program or Repeat Play. Repeat Play can repeat all the tracks or just one of the tracks on the CD. Here are the basic things you need to know to play a CD and locate the different tracks on it.

## The Fastest Way To Start Playing a CD Is With COMPU PLAY (One Touch Operation)

- Press the CD ▷/|| button on the Unit or the Remote Control.
  - The power is automatically turned on. If a CD is already loaded, it will start playing from the first track.
  - If no CD is inserted, "NO DISC" appears on the display and the CD Player does not play.

## Loading a CD

- 1. Press the CD OPEN/CLOSE ▲ button on the Unit or the CD ▲ button on the Remote Control.**

The CD cover opens.

- 2. Place a CD into a compartment, with its label side out as shown below. Press down on the CD's center until you hear a click.**

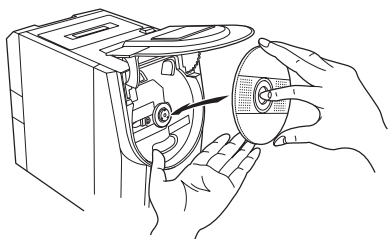

- 3. Press the CD OPEN/CLOSE ▲ button (or CD ▲ button) again to close the CD cover.**

- To close the CD cover and play the CD, you can simply press the CD ▷/|| button.
- You do not need an adaptor to play a 8 cm (3") CD.
- If the CD is scratched or damaged, "0 0:00" appears on the display.
- You can load a CD while listening to the other source.

### CAUTIONS:

- **DO NOT try to open or close the CD cover by hand. This can damage it.**

- **When you place or take out a CD, do not let it fall. Also, be careful not to scratch your fingers with the CD cover.**

## Unloading a CD

Take out the CD as shown below.

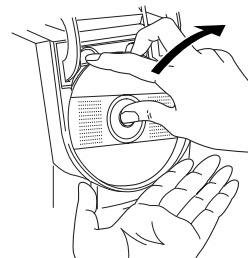

- To unload an 8 cm (3") CD, use the hole make removal easier.

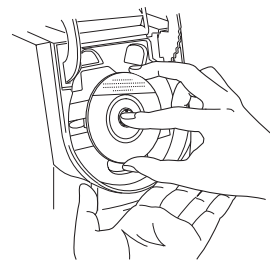

## Playing a CD (Normal Play)

### To Play a CD

- 1. Load a CD.**
- 2. Press the CD ▷/|| button.**

The first track of the CD begins playing.

1 0:05  
Track number    Playing time

- The track number that has already played disappears from the music calendar.
- The CD Player automatically stops when the last track of the CD has finished playing.

To stop playing the CD, press the ■ button.  
The following information for the CD is displayed.

18 50:45  
Total track number Total playback time

To remove the CD, press the CD OPEN/CLOSE ▲ button on the Unit or CD ▲ button on the Remote Control to open the CD cover.

To pause, press the CD ▷|| button. The playback time blinks on the display.

To cancel pause, press the same button again. Play continues from the point where it was paused.

## To Select a Track or Passage within a Track

During playback, press the ◀ or ▶ (< or >) button to select the track you want.

The selected track starts playing.

- Press the ▶ or > button once to skip to the beginning of the next track.
- Press the ◀ or < button to skip to the beginning of the track being played. Press twice quickly to skip to the beginning of the previous track.
- When you hold down the > or < button on the remote control, you will quickly change from track to track.

## Search Play

To quickly find a particular passage in the track you are listening to, hold down the ◀ or ▶ buttons during playback. The CD will fast forward or backward with the audio playing.

## Programming the Order of Tracks

You can decide which order to play tracks on your CD player using the Remote Control.

- You can program up to 20 tracks in any desired order including repeating the same tracks.
- You can only program tracks when the CD player is stopped.

- Load a CD.
- Press the CD ▷|| button.
- Press the ■ button to stop the CD.
- Press the PROGRAM button.

The System is ready to program and the “CD PROGRAM” indicator lights up.



- Press the UP, DOWN, >, or < button to select the track to program.

- UP or > button: Increases the track number by 1.  
DOWN or < button: Decreases the track number by 1.
- When you hold down the > or < button on the remote control, you will quickly change from track to track.

- Press the SET button.

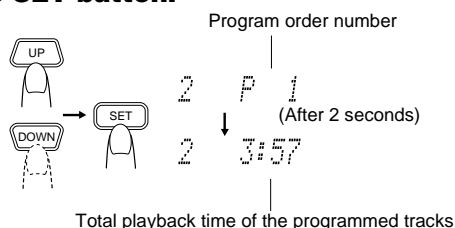

- Repeat steps 5 and 6 to select the other tracks for the program.

You can see the total playback time of programmed tracks on the display. Also, you can see the programmed tracks on the music calendar.

- Press the CD ▷|| button.

The System plays the tracks in the order you have programmed them.

- You can skip to a particular program track by pressing the ◀◀ or ▶▶ button during Program Play.
- To stop playing, press the ■ button once.

To confirm the programmed tracks, while the CD player is stopped, each time press the ◀◀ or ▶▶ button; the tracks making up the program will successively be displayed in the programmed order.

To delete all the tracks in the program, in stop mode, press the ■ button. Pressing the CD ▲ button to open the CD cover will also clear the programmed tracks.

To exit the program mode, while the CD Player is stopped, press the PROGRAM button to turn off the “CD PROGRAM” indicator.

- Even if the power is turned off, the programmed contents remain in effect, through the Program mode is cleared.

### Notes:

- If the total playback time of the programmed tracks exceeds 99 minutes 59 seconds, the total playback time will go out on the display.
- If you try to program the 21th track, “MEMORY FULL” appears on the display for about 2 seconds.

## Deleting Tracks

To delete tracks, press the CANCEL button while CD Player is stopped. The last track in the program will be deleted. To add new tracks to the end of the program, repeat 5 to 7 under “Programming the Order of Tracks.”

## Random Play

The tracks will play in no special order when you use this mode.

- Press the RANDOM button on the Remote Control.

The “CD RANDOM” indicator lights up on the display.

- Press the CD ▷|| button.

The tracks are played in random order.

To skip a track during playback, press the ▶▶ button to jump to the next track in the random sequence. Press the ◀◀ button to jump back to the start of a track being played.

To exit Random Play mode, while the CD Player is stopped, press the RANDOM button to turn off the “CD RANDOM” indicator. Or you can press the CD ▲ button to open the CD cover. You can also exit Random Play by turning off the power.

## Repeating Tracks

You can repeat random or programmed tracks as many times as you like.

Press the REPEAT button on the Remote Control.

The Repeat indicator changes with each press of the button, as shown below.

- ↶ → ALL → blank display → (back to the beginning)
- ↶ : Repeats one track.
- ↶ ALL : In Normal Play mode, repeats all the tracks. In Program Play mode, repeats all the tracks in the program. In Random Play mode, repeats all the tracks in random order.

To exit Repeat mode, press the REPEAT button until the Repeat indicator on the display goes out. Or you can press the CD ▲ button to open the CD cover.

- In Random Play, ↶ cannot be selected.
- Repeat mode remains in effect even when you change the play mode.

# Using the Video CD Player (Video CDs, CD-Gs)

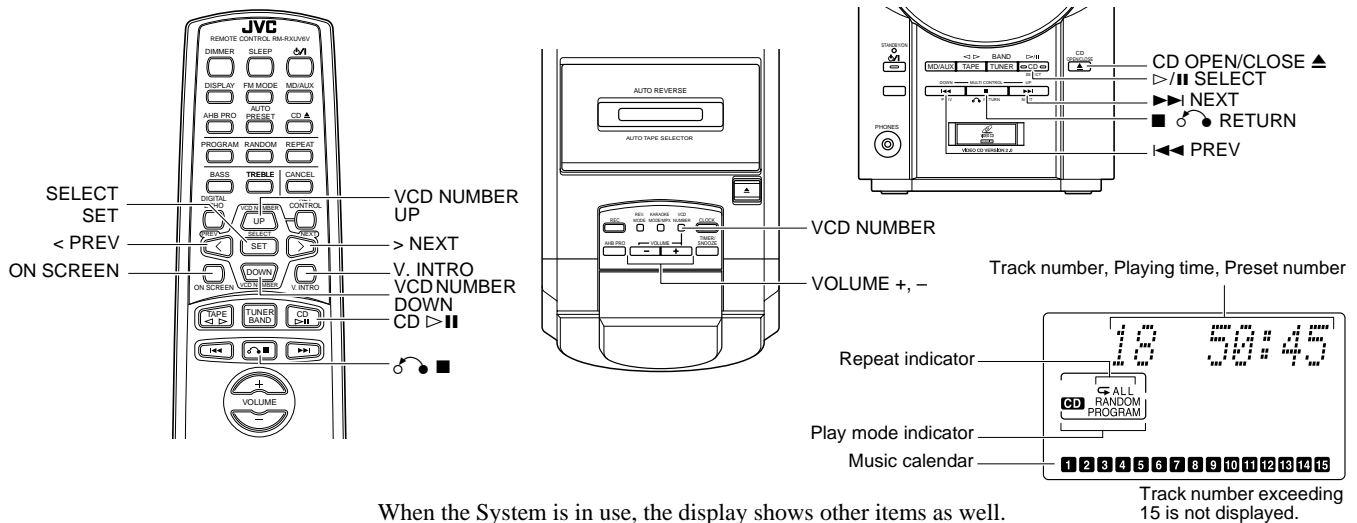

When the System is in use, the display shows other items as well.  
For simplicity, we show here only the items described in this section.

You can play video CDs (with or without the Playback Control (PBC) function) and CD Graphics (CD-Gs) to watch the picture on your TV while listening to the sound on video CDs and CD-Gs.

## ■ Before playing video CDs and CD-Gs

- Make sure that the connection between the System and your TV is correct. If you wish, you can listen to the music on your TV by connecting the LINE OUT signals to your TV. (See page 4.)

## Setting the TV System

To view a picture of video CDs or CD-Gs, it is required to set the System's TV system according to your TV system.

Relationship among the playable CDs, System's TV system and your TV system:

Playable CD	System's TV system	Your TV system
NTSC/PAL	NTSC	NTSC
NTSC/PAL	PAL	PAL
NTSC/PAL	PAL AUTO	Multisystem

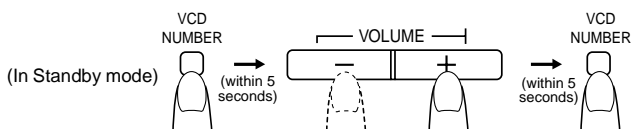

### 1. Turn off the power to set the System in Standby mode.

### 2. Press the VCD NUMBER button on the Unit for more than two seconds.

The current TV system ("NTSC" for example) appears on the display for five seconds.

### 3. Within five seconds, press the VOLUME + (or -) button to select the TV system.

Each time you press the button, the TV system changes as follows.

NTSC → PAL → PAL AUTO → (back to the beginning)

NTSC: for NTSC exclusive TV

PAL: for PAL exclusive TV

PAL AUTO: for multisystem TV

### 4. Within five seconds, press the VCD NUMBER button on the Unit.

### 5. Turn on the TV and select the video input on the TV.

### 6. Press the MD/AUX or TAPE button to turn on the System.

"Video CD JVC" screen will appear on the TV without distorting.

#### Notes:

- If you play an NTSC CD in PAL AUTO system on a PAL exclusive TV, the image may be distorted. If this happens, change to "PAL".
- When you play an NTSC CD in PAL AUTO system on a multisystem TV, the image may blink for a moment. This symptom occurs when the System detects the formula of the CD and is not a malfunction.

## Playing Video CDs with PBC Function

The System provides a Playback Control (PBC) function which utilizes a procedure (menu selection) programmed in a video CD.

### What is the Playback Control (PBC) function?

The PBC function allows you to enjoy the following features.

- Menu-driven playback  
You can interact with the TV screen using a menu display to select and play an entry.
- High-resolution still image display  
You can display high-quality images four times clearer than video pictures.
- For operation, refer to the instructions supplied for the video CD.
- To use video CDs as a Karaoke source, see page 22.
- You can play video CDs with PBC function using the menu screen (Menu-Driven Play) or without using the menu screen (Continuous Play).

### Notes:

- The playback operation procedure may differ depending on the video CD you use.
- Sometimes due to improper manufacturing, video CDs will function differently.

## Playing Video CDs with the PBC Function Using the Menu Screen (Menu-Driven Play)

- Before playing, make sure that Repeat indicator "↺" or "↻ALL" is not lit. If lit, press the REPEAT button on the Remote Control until it disappears.

### 1. Load a video CD with the PBC function.

### 2. Press the CD ▷/|| button.

"PBC" appears on the display and the first menu will appear on the TV screen.

- If you leave your System, the TV screen will change as follows.

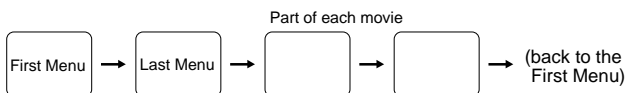

To return to the first menu in the screen other than the first menu, press the RETURN button on the Unit or RETURN button on the Remote Control.

### 3. To move through the next menu, press the following button.

**On the Unit:**

Press the NEXT or PREV button.

**On the Remote Control:**

Press the NEXT or PREV button.

### 4. To select the item (track) in the menu and play it, press the following buttons.

**On the Unit:**

1. Press the VCD NUMBER button. "SEL 1" will blink on the display.
2. Press the VOLUME + or - button to select the item ("SEL XX") and press the SELECT button to play it back.

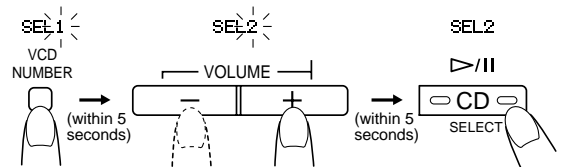

**On the Remote Control:**

1. Press the VCD NUMBER UP or DOWN button to select the item ("SEL XX") you want to play.
2. Press the SELECT button to play it back.

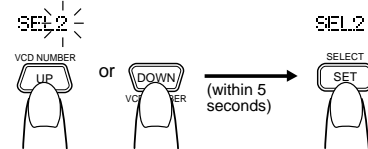

- The next track will be automatically played after the current track is finished.
- While a part of movie is displayed on the TV in step 2, pressing the SELECT button on the Unit or the SELECT button on the Remote Control causes the track being played to play from the beginning.

**To pause,** press the CD ▷|| button on the Remote Control.

**To stop playback and return to the first menu,** press the RETURN button.

**To stop the video CD,** press the RETURN button for more than two seconds during playback. A blue appears on the TV screen.

**To select other item during playback,** repeat step 4.

### Notes:

- Program Play, Random Play and Repeating Tracks cannot be made in this Menu-Driven Play.
- When the video CD is paused for about 10 minutes, the screen background automatically fades out to prevent screen burn-in.

### Basic Remote Control and Unit Button Functions for Menu-Driven Play:

Remote Control	Unit*	Function
PREV / NEXT	PREV / NEXT	Move through menu.
VCD NUMBER UP/DOWN	VCD NUMBER ↓ VOLUME +/-	Select a specific menu item.
SELECT	SELECT	Enters the selected video CD number or item. When a part of movie is displayed on the TV screen, starts playing that track from the beginning.
RETURN	RETURN	Returns to the previous menu during playback. Stops the video CD during playback by pressing for more than 2 seconds.

\* The PBC function button names on the unit are printed in blue.



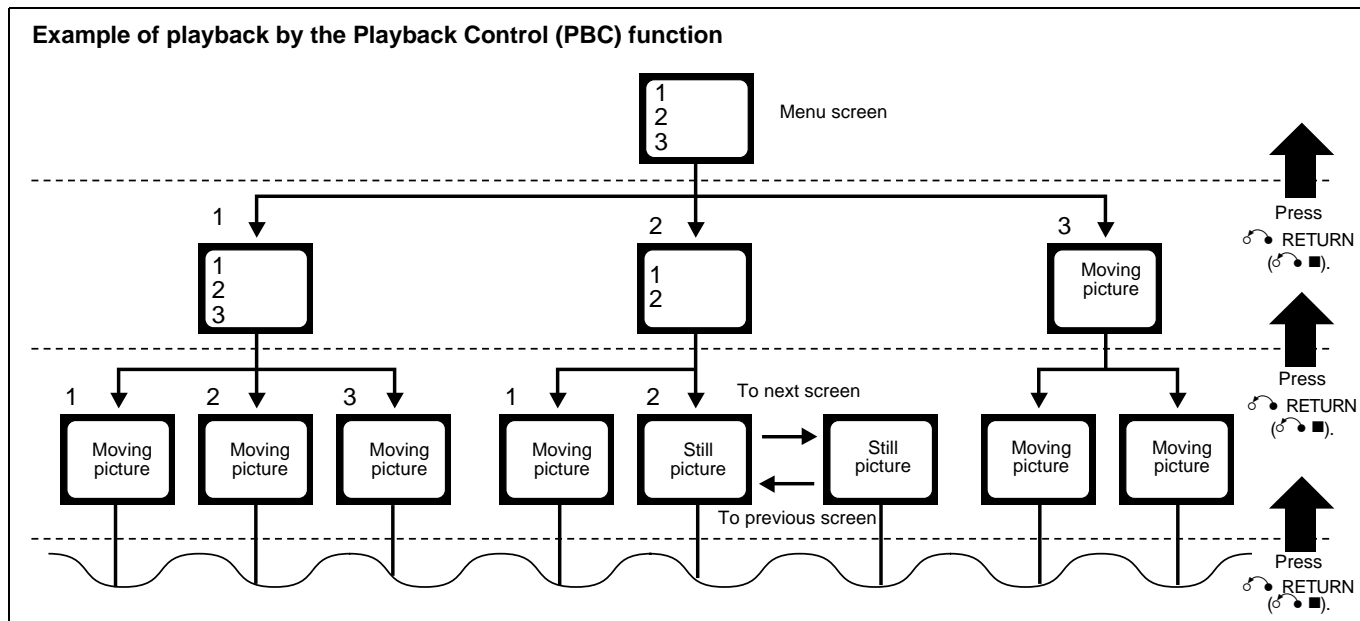

A selection menu is displayed when you start playing a video CD with the PBC function. The selection menu shows a list of numbers for selection. Some video CDs may show moving pictures or a divided screen.

- When a list of numbers is displayed, selecting a number shows its contents.
- When a moving picture is displayed, pressing SELECT at the time when a part of the movie you desire is shown plays the movie.
- When the selection menu is re-displayed after you have played your selection, selecting a number again can replay its contents. (Some video CDs may show the menu screen several times.)  
When "NEXT" and "PREV" are shown, pressing NEXT or PREV can change the selection menu.
- After playback, press RETURN (⏪) to go back to the previous screen. After playback, pressing RETURN (⏪) for 2 seconds or more causes it to stop. Some video CDs may return you to the menu screen shown before playback.

#### Notes:

- When a menu is displayed for a long time, about 10 minutes, the screen background automatically fades out to prevent screen burn-in while the setting is suspended.
- When using the REPEAT function, the PBC function is not available.

### Playing Video CDs with PBC Functions without Using the Menu Screen (Continuous Play)

You can play the video CDs with the PBC function without using the menu screen, as if they were without the PBC function.

#### 1. Load a video CD with the PBC function.

#### 2. Select the playback mode. (Do not press the CD button.)

##### Normal Play:

Press the button (or > button on the Remote Control) to select the track you want to play.

- For example, to start from the beginning, press the button once to select the track 1.

#### Program Play, Random Play, Repeating Tracks:

Select the mode by pressing respective buttons on the Remote Control in the same way as for audio CDs. (See page 11.)

#### 3. Press the CD button to play the video CD.

### Playing video CDs without the PBC Function

Basic playback procedures for video CDs are the same as for audio CDs. (See pages 10 and 11.)

- When you start playing a video CD without the PBC function, "VIDEO CD" appears on the display.
- To use a video CD without the PBC function as a Karaoke source, see page 22.

#### Notes:

- During playback a video CD, the following operations may distort the image on the TV screen.  
Searching for the beginning of the track, Skipping the tracks, Stopping/pausing the tracks, or Frame-by-frame playback
- If paused for more than 10 minutes, the screen background automatically fades out to prevent screen burn-in.

### Playing CD-Gs

Basic playback procedures for CD-Gs are the same as for audio CDs. (See pages 10 and 11.)

- When you start playing a CD-G, "GRAPHICS" appears on the display.
- To use a CD-G as a Karaoke source, see page 22.

#### Notes:

- During playback a CD-G, the following operations may distort the image on the TV screen.  
Searching for the beginning of the track, Skipping the tracks, or Stopping/pausing the tracks
- If paused for more than 10 minutes, the screen background automatically fades out to prevent screen burn-in.

## Various Functions to Enhance Your Enjoyment

You can use the following features **using the Remote Control**.

### Frame-by-Frame Playback

Frame-by-Frame Playback is possible only when moving pictures (of the video CDs with or without the PBC function) are played.

**During playback, press the CD ▷/|| button to pause the video CD and then press the ►► button.**

Each time you press the ►► button, the picture advances by one frame. During Frame-by-Frame Playback, no sound comes out.

**To resume Normal Play, press the CD ▷/|| button.**

- You cannot gain access to the previous frame. (The ◀◀ button is ineffective.)

### Display of Operating Status

You can view the current operating status on the TV screen.

**Press the ON SCREEN button.**

Each time you press the button, the on-screen display turns on and off, and the following screen is shown for three seconds.

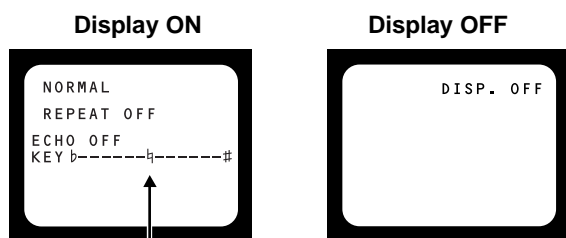

Music key level

- Once you have turned on the on-screen display, the track number and playing time are always displayed on the TV screen. When you play a video CD with the PBC function, "PBC" will be also displayed on the TV screen.

## Viewing the Video Intro of Video CDs

You can check the contents of a video CD, watching the first five seconds of each track on the video CD.

### 1. Play the video CD.

**Video CD with the PBC function:**

Perform Continuous Play. (See page 14.)

- For example, to start from the beginning, press the ►► button once to select the track 1 and then press the CD ▷/|| button.

**Video CD without the PBC function:**

Press the CD ▷/|| button.

### 2. Press the V.INTRO button after a picture appears on the TV screen.

The Video Intro Play starts and the first five seconds of nine tracks are played in sequence.

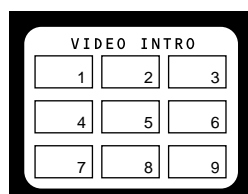

- If the video CD has more than nine tracks, the tracks whose track number is greater than nine will be displayed after the first nine tracks have been displayed.

**To select a track during Video Intro Play, press the VCD NUMBER UP or DOWN button to select the track and then press the SELECT button.** Continuous Play starts from the selected track. When you use the Unit, press the VCD NUMBER button and press the VOLUME + or - button to select the track. Then, press the CD ▷/|| button.

**To stop and cancel the Video Intro Play, press the ⏏ button.**

# Using the Cassette Deck (Listening to a Tape)

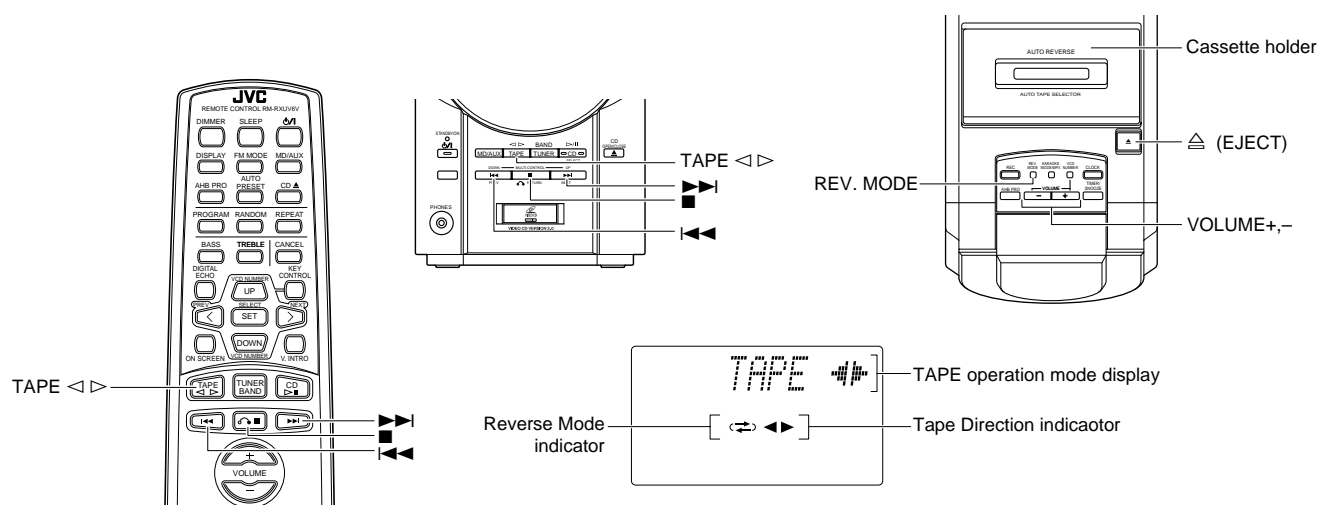

When the System is in use, the display shows other items as well. For simplicity, we show here only the items described in this section.

The Cassette Deck allows you to play and record audio tapes.

- With Automatic Tape Detection, you can listen to type I, II or IV tapes without having to change any settings.

The use of tapes 120 min. or longer is not recommended, since characteristic deterioration may occur and these tapes easily jam in the pinch-rollers and the capstans.

## One Touch Play

By pressing the TAPE < > button on the Unit or the Remote Control, the Unit will come on. "TAPE" appears in the display, and if a tape is in the deck, it will start to play. If no tape is loaded, "NO TAPE" appears on the display, the Unit will come on and wait for you to load a tape, or select another function.

## Regular Play

When the power is already on, you can use this basic procedure:

1. Press the  $\triangle$  (EJECT) button.
2. When the cassette holder opens, put the cassette in, with the side you want to listen facing up.
  - If the cassette holder does not open, turn the Unit off, then back on and press the  $\triangle$  (EJECT) button again.

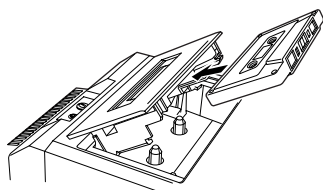

3. Close the holder gently until it clicks.

4. Press the TAPE < > button.

The tape is played in the direction shown by the Tape Direction indicator.

## 5. If you need to change the playback direction, press the TAPE < > button again.

The opposite side Tape Direction indicator lights up and the tape playback direction changes.

To stop playing, press the  $\blacksquare$  button.

To remove the tape, stop the tape, and press the  $\triangle$  (EJECT) button.

## To Fast-Wind A Tape

- Press the  $\gg|$  or  $|<<$  button on the Unit or the Remote Control to fast-wind the tape.  $\gg|$  or  $|<<$  indicator of the tape fast-wind direction appears on the display.

- The Cassette Deck automatically stops when the tape reaches its end.

## Reverse Mode

You can set a tape to play just one side, both sides in succession, or both sides continuously.

Press the REV. MODE button on the Unit.

The indicator changes with each press of the button as shown.

$\rightleftarrows \rightarrow \rightleftarrows \rightarrow \rightleftarrows \rightarrow$  (back to the beginning)

- $\rightleftarrows$ : The Cassette Deck automatically stops after playing one side of the tape.
- $\rightleftarrows \rightarrow$ : The Cassette Deck automatically stops after playing both sides of the tape. (Stops when playback in the  $\blacktriangleleft$  direction is finished.)
- $\rightleftarrows \rightarrow \rightleftarrows$ : The Cassette Deck continues to play both sides of the tape until the  $\blacksquare$  button is pressed.

# Using the Cassette Deck (Recording)

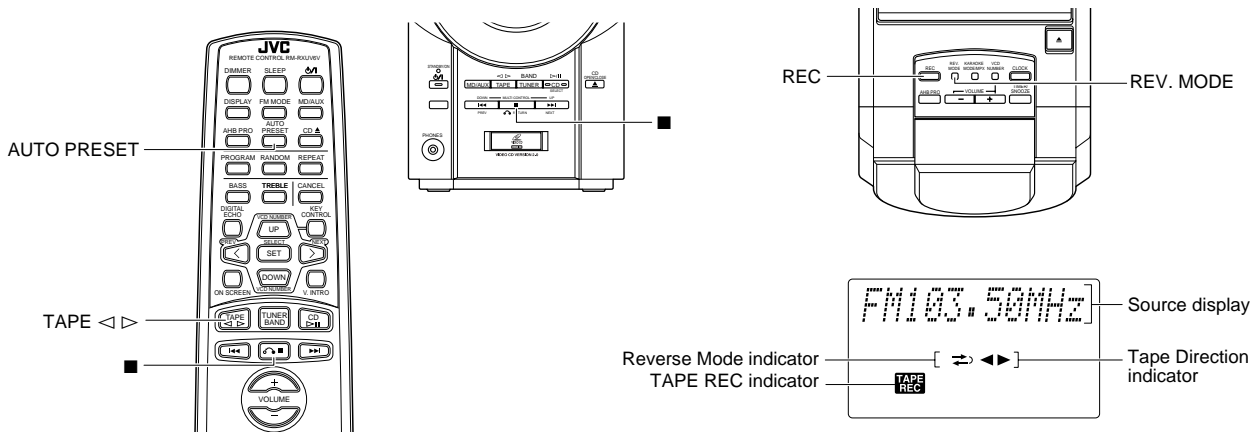

When the System is in use, the display shows other items as well.  
For simplicity, we show here only the items described in this section.

Recording onto a tape from any of the sound sources is simple. Just place a tape in the Cassette Deck, have the source ready, make one or two settings, and you are ready to record. For each source the procedure is a little bit different so we explain each separately. But first, here are a few things to make your recordings better.

## Things To Know Before You Start Recording

- It may be unlawful to record or play back copyrighted material without the consent of the copyright owner.
- When you want to record onto both sides of a tape, you can set Reverse mode to do so. Recording automatically stops after recording in the ◀ direction. Therefore, make sure that the tape direction is ▶ when recording with Reverse mode on.
- The recording level, which is the volume at which the new tape is being made, is automatically set correctly, so it is not affected by the VOLUME control on the System. Nor is it affected by adjusting the sound effects. Thus, during recording you can adjust the sound you are actually listening to without affecting the recording level.
- Two small tabs on the back of the cassette tape, one for side A and one for side B, can be removed to prevent accidental erasure or recording.

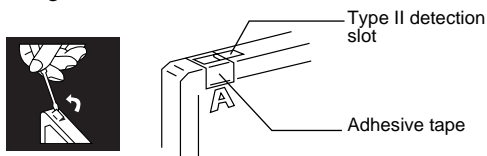

- To record on a cassette with the tabs removed, you must cover the holes with adhesive tape first. However, when a type II tape is used, only cover part of the hole as shown, since the other part of the hole (Type II detection slot) is used to detect the tape type.
- Type I and Type II tapes can be used for recording.

**Note:** At the start and end of cassette tapes, there is leader tape which cannot be recorded onto. Thus, when recording CDs or radio broadcasts, wind on the leader tape first to ensure getting the beginning of the recording.

**CAUTION:** If a recording you make has excessive noise or static, the Unit may have been too close to a TV during the recording. Either turn off the TV or increase the distance between the TV and the System.

## Standard Recording

You can record any sound source to tape as follows:

- 1. Load a blank or erasable tape into the Cassette Deck and wind past the tape leader.**
- 2. Press the REV. MODE button on the Unit if you want to record on both sides of the tape.**  
Press the button until the ⇄ indicator is lit.
  - When using Reverse mode, insert the tape so that it will be recorded in the forward ▶ direction.
- 3. Check the recording direction for the tape.**  
Make sure that the Tape Direction indicator is the same as that for the tape in the Cassette Deck. If the directions are different, press the TAPE ◀ ▶ button to correct the tape direction and then press the ■ button to stop the tape.
- 4. Prepare the source, by, for example, tuning in a radio station or turning on connected auxiliary equipment.**

**Note:** For CD recording, refer to “CD Direct Recording” mentioned on page 18.

- 5. Press the REC button on the Unit.**

The “TAPE REC” indicator lights up and the System begins recording.

- If the tab of the cassette tape is removed to prevent erasure or recording, “NO REC” will appear on the display.

## Notes for using Reverse mode for recording

When recording in Reverse mode, the System automatically stops when it reaches the end of the reverse ◀ direction. To record on both sides of a tape, make sure that the recording direction for the tape inserted is forward ▶, and that the Tape Direction indicator is also forward ▶, before you start recording.

## To Stop at Any Time During the Recording Process

Press the ■ button.

## Recording an AM station to tape

When recording an AM broadcast, beats may be produced which are not heard when listening to the broadcast. If this happens, press the AUTO PRESET button on the Remote Control to eliminate the beats.

1. Set to AM station and start recording.
2. Press the AUTO PRESET button to eliminate the beats. Each time you press the button, the display changes as shown below:  
CUT-1 → CUT-2 → CUT-3 → (back to the beginning)

## CD Direct Recording

Everything on the CD goes onto the tape in the order it is on the CD, or according to the order you have set in a program.

1. **Load a cassette into the Cassette Deck and wind past the tape leader.**
2. **Load a CD.**
3. **Press the CD ▷/|| button on the Unit or on the Remote Control.**
4. **Press the ■ button.**
  - If you want to record specific tracks only, program the tracks beforehand. You can check their total playback time on the display during programming. (See page 11.)
5. **If you want to record on both sides of a tape, press the REV. MODE button on the Unit until the “↔” indicator is lit. Make sure that the recording direction for the tape and the Tape Direction indicator is correct. (See “Notes for using Reverse mode for recording”.)**
6. **Choose whether to have pauses between recorded selections.**
  - If nothing is done, a non-recorded pause of about four seconds will be automatically left between selections.
  - If you do not want pauses between selections, do the following before proceeding to the next step.

**Press the CD ▷/|| button on the Unit or the Remote Control twice.**

The CD player enters Pause mode.

### Note on video CDs:

When playing a video CD with the Playback Control function using the menu screen (Menu Driven Play), you cannot carry out the CD Direct Recording.

When you carry out the CD Direct Recording for a video CD with the Playback Control function, play it back without using the menu screen (Continuous Play). (See page 14.)

7. **Press the REC button on the Unit.**

The “TAPE REC” indicator lights up and the System begins recording.

- If you make a recording with Reverse mode on, the Unit will record the last song at the end of the first side onto the next side from its beginning when the song has been recorded more than 12 seconds on the first side. If the last song has been recorded less than 12 seconds, then the previous song will again be recorded on the next side as it will not be completely recorded on the first side because of leader tape.
- After the CD player has played the entire CD, or all the programmed tracks, the tape automatically stops.

**To stop at any time during the recording process**, press the ■ button. The tape stops after four seconds.

**Note:** When making SLEEP timer settings while doing CD Direct recording, set enough time to allow for the CD to finish playing, otherwise the power will go off before recording is completed.

## One Track Recording

1. **Load a cassette into the Cassette Deck and wind past the tape leader.**
2. **Play the track on the CD you wish to record.**
3. **Press the REC button on the Unit.**

The CD player returns to the beginning of that track and the track is recorded on the tape. After recording, the CD player and Cassette Deck automatically stop.

### Note on video CDs:

When playing a video CD with the Playback Control function, one track recording cannot be made if the track is selected by using the menu (“NO REC” will appear on the display). To allow one track recording, use Continuous Play. (See page 14.)

## Erasing

A recorded tape can be erased by recording new material over the previous material.

**To erase a tape without making a new recording:**

1. **Press the TAPE ◁ ▷ button to set to the TAPE mode.**
2. **Load the cassette with the side to be erased facing up.**
  - Make sure that the Tape Direction indicator ▶ (forward) lights up.
3. **Press the REC button.**

# Using External Equipment

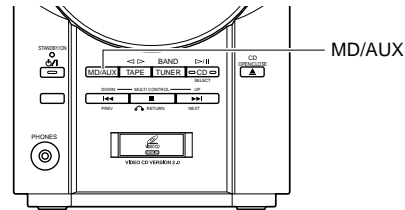
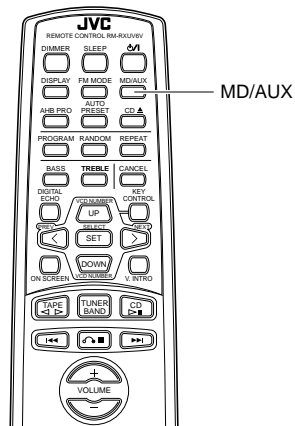

## Listening to External Equipment

You can listen to external equipment such as MD recorder, etc.

■ First make sure that the external equipment is properly connected to the System. (See page 4.)

**1. Set the VOLUME control to the minimum position.**

**2. Press the MD/AUX button.**

“AUX” appears on the display.

AUX

**3. Start playing the external equipment.**

**4. Adjust the VOLUME control to the desired listening level.**

**5. Apply sound effects, if you wish.**

■ Press the AHB PRO button to reinforce the bass sound.

■ Press the BASS/TREBLE button on the Remote Control to control the tone. (See “Tone Control” on page 7.)

To exit MD/AUX mode, you will automatically switch out of MD/AUX mode when you select another source.

**Note:** For operation of the external equipment, refer to its Instructions.

## Recording the System's source to External Equipment

You can record the System's source to external equipment which is connected to the LINE OUT or OPTICAL DIGITAL OUT terminals of the System, such as cassette deck, MD recorder, etc.

■ First make sure that the external equipment is properly connected to the System. (See pages 4 and 5.)

**1. Play the System's CD Player, Cassette Deck, or tune into a station.**

■ The recording level is not affected by the VOLUME level set by the System. Also it is not affected by the sound effects.

### Notes:

- For operation of the external equipment, refer to its Instructions.
- No audio signal will be output from the OPTICAL DIGITAL OUT terminal if a video CD is played. For a CD-G and audio CD, the audio signal is output.

# Using the Timers

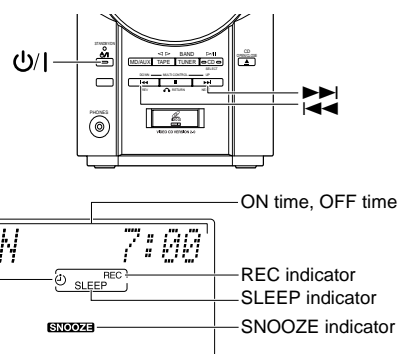
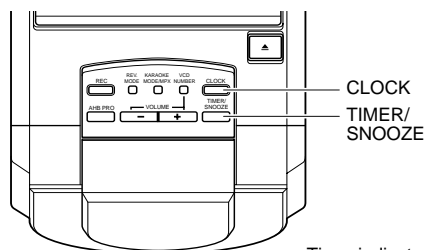
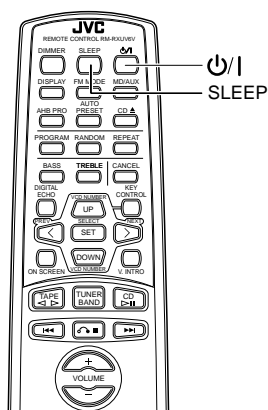

When the System is in use, the display shows other items as well.  
For simplicity, we show here only the items described in this section.

The timers let you set your System to turn off automatically, or to use it like an alarm clock.

Once you have set the daily timer, the System will turn on and off again at whatever time you select, every day.

In addition to the digital clock, the analog clock also shows the time.

## Setting the Clock

- When you plug the AC power cord into the wall outlet, the time indication blinks on the display.

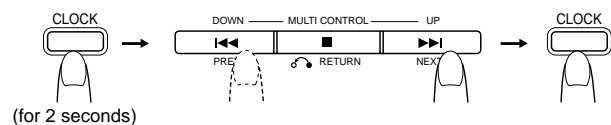

- Press the **CLOCK** button on the Unit for more than two seconds.

The time indication rapidly blinks on the display.

- Press the **▶▶** or **◀◀** button on the Unit to set the time.

Pressing the **▶▶** button moves the time forwards and pressing the **◀◀** button moves it backwards. Hold down the button to move the time rapidly.

- Press the **CLOCK** button.

The selected time is set and the seconds start counting from 0.

### Notes:

- The clock must be correctly set for the timers to work.
- The procedure must be completed within two minutes. Otherwise, the setting is cleared and must be repeated from the beginning.

**CAUTION: If there is a power failure, the clock loses its setting after about 20 minutes. "0:00" blinks on the display and the clock must be reset.**

**Note:** The clock may gain or lose one to two minutes per month.

## Setting the Daily Timer

Once you have set the Daily Timer, the timer will be activated at the same time every day. It can be cancelled and re-activate whenever you wish.

The Timer indicator on the display shows when the Daily Timer you have set is in effect.

**Note:** Perform each setting within 30 seconds. Otherwise, setting is cleared and the procedure must be repeated from the beginning.

- Press the **⏻** button to turn on the System.

- Setting the **ON** time (Example: 12:15).

- Press the **TIMER/SNOOZE** button on the Unit.  
The Timer indicator lights up and the current ON time blinks on the display.

- If you have not first set the clock, the "CLOCK" indicator and the "ADJUST" indicator appear alternately on the display. Set the clock first.

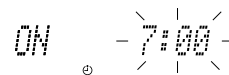

- Press the **▶▶** or **◀◀** button on the Unit to set the time you want the Unit to turn on.

The **▶▶** button moves the time forwards and the **◀◀** button moves it backwards. Hold down the button to move the time rapidly.

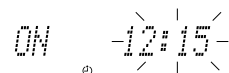

- Setting the **OFF** time (Example: 13:15).

- Press the **TIMER/SNOOZE** button on the Unit.  
The current OFF time blinks on the display.



- Press the **▶▶** or **◀◀** button on the Unit to set the time you want the Unit to be turned off.

Pressing the **▶▶** button moves the time forwards and pressing the **◀◀** button moves it backwards. Hold down the button to move the time rapidly.

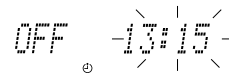

- Selecting the music source.

- Press the **TIMER/SNOOZE** button on the Unit.  
The "TUNER" blinks on the display.
- Press the **▶▶** or **◀◀** button to select the music source you want to listen to.  
The display changes as shown below.

**TUNER** ↔ **TUNER REC** ↔ **CD** ↔ **TAPE** ↔ (back to the beginning)

- If you select the "TUNER REC", the "REC" indicator appears on the display.

## 5. Setting the volume level.

1. Press the TIMER/SNOOZE button on the Unit.  
The volume level set by the previous timer setting blinks on the display.
2. Press the ►► or ◄◄ button to select the volume level.  
-- : The current volume level will be used.  
0 to 50: When the timer is turned on, the Volume will be automatically set to the selected level.



## 6. Press the TIMER/SNOOZE button on the Unit.

The timer setting is completed, and the timer indicator remains lit.

## 7. Before turning off the System, make sure you have selected a music source in step 4.

TUNER: Tune in to the desired station.

TUNER REC: Tune in to the desired station and load a cassette tape for recording the station.

CD: Load a CD.

TAPE: Load a tape.

## 8. Press the ⏻ button to turn off the System.

**To cancel the timer**, press the TIMER/SNOOZE button. The Timer indicator goes out on the display.

**To turn on the cancelled timer**, press the TIMER/SNOOZE button to light the Timer indicator. Then, press the TIMER/SNOOZE button until the display returns to the original display. The Timer indicator should remain lit.

**To confirm the timer settings**, cancel the timer once by pressing the TIMER/SNOOZE button. Then, press the TIMER/SNOOZE button repeatedly, to see the current timer settings (ON time, OFF time, source, and volume).

**To change the timer setting**, repeat the setting procedure from the beginning.

- When the timer turns on, the Timer indicator will blink.

**CAUTION: If the System is unplugged, or a power failure occurs, you will lose the timer setting and you will have to reset them.**

## 5-Minute Snoozing

When the timer turns on the music on, you can turn it off for 5-minute.

### Press the TIMER/SNOOZE button on the Unit.

The “SNOOZE” indicator lights up on the display and the music will turn off for five minutes.

## Setting the SLEEP Timer

### (Using the Remote Control)

By setting the Sleep Timer, you can fall asleep to music and know that your system will turn off by itself rather than play all night.

- You can only set the Sleep Timer when the System is on and a source is playing.

### 1. Play a CD, a cassette tape, or tune in to the desired station.

### 2. Press the SLEEP button on the Remote Control.

The “SLEEP” indicator lights up.

- If you have not first set the clock, the “CLOCK” indicator and the “ADJUST” indicator appear alternately on the display. Set the clock first.

### 3. Set the length of time you want the System to play before it turns off.

- Each time you press the SLEEP button, the timer changes as follows:  
**10 → 20 → 30 → 60 → 90 → 120 → Cancelled** → (back to the beginning)

After you set the number of minutes, the display stops blinking and returns to the normal display. (The display is dimmed.)

The System is now set to turn off after the number of minutes you set.

**To Confirm the Sleep Time**, press the SLEEP button once and the remaining time will be displayed. In a few moments, the display will return to normal.

**To Cancel the SLEEP Timer Setting**, press the SLEEP button until the “SLEEP” indicator goes out.

You can also cancel the Sleep Timer by simply turning the System off.

- If you are setting the Daily Timer, the System will be turned on at the set time to wake you up.



# Using the Microphone

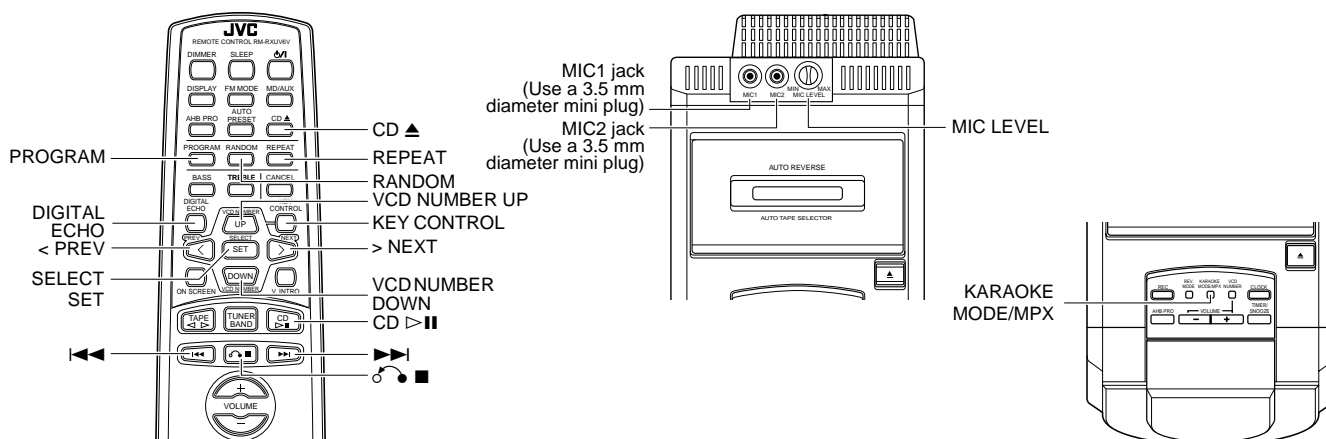

The System includes two microphone terminals, MIC 1 and MIC 2. By attaching a microphone to one or both these terminals, you can use the System for Karaoke or microphone mixing. You can also add an echo to the microphone's sound except when Tuner is selected as a source.

■ The MIC LEVEL control adjusts the volume for both MIC 1 and MIC 2 at the same time.

■ When you will not be using the microphone, keep the MIC LEVEL control set to MIN, and disconnect the microphone.

**CAUTION: Always set the MIC LEVEL control to MIN when connecting or disconnecting the microphone.**

## Singing Along-Karaoke

You can enjoy singing along using audio CDs, video CDs and CD-Gs. (Karaoke does not function for other sources such as tape.) While singing along, you can apply echo and adjust the music key.

### Singing Along with Audio CDs-Vocal Masking

When playing an audio CD, you can reduce the lead vocal and replace it with your voice by singing into the microphone(s).

The following CDs are not suitable for Vocal Masking.

- Monaural CDs
- Multiplex Karaoke CDs
- CDs recorded duets, strong echo, a chorus, or only a few instruments

- 1. Set the MIC LEVEL control to MIN by turning it counterclockwise.**
- 2. Connect a microphone (not supplied) by plugging it into the MIC 1 and/or MIC2 jack.**
- 3. Press the KARAOKE MODE/MPX button on the Unit until "V.MASKING" appears on the display.**

Each time you press the button, Karaoke mode changes as follows.

Lch MONO → Rch MONO → V. REPLACE → V.MASKING → NORMAL → (back to the beginning)

- You can also select "V.MASKING" during playback.

- 4. Play an audio CD.**

### 5. Adjust the main volume and the MIC LEVEL control, as you sing into the microphone.

- If you want to record on a tape, carry out CD Direct Recording or One Track Recording. (See page 18.)

To cancel the Karaoke mode, press the KARAOKE MODE/MPX button until "NORMAL" appears on the display.

#### Notes:

- After finishing singing along, always cancel the Karaoke mode. Karaoke mode will be also cancelled if you change the function or turn off the power.
- If "howling" occurs, keep the microphone away from the speakers.
- When digital recording is made to an external equipment through the OPTICAL DIGITAL OUT terminal using an audio CD, the microphone sound is not recorded.
- During recording, you cannot change the Karaoke mode.

### Singing Along with Multiplex Karaoke CDs-MPX (Multiplex)/Vocal Replace Sound

If the source you are going to play is a multiplex Karaoke CD, you can use the two functions; Multiplex Sound and Vocal Replace.

#### What is Multiplex Sound?

In a multiplex Karaoke CD, the instrumental parts are recorded on the left channel and the vocal parts are recorded on the right channel. With this system, you can select the playback sound with your voice through the microphone (With this system, you can select each channel separately.).

#### What is Vocal Replace?

By using this function, you can replace the lead vocal (recorded on the right channel) with your voice as you sing into the microphone. If you stop singing, while a source is still playing, the original vocal sound automatically resumes.

- 1. Turn on the TV and select the video input on the TV.**
- 2. Set the MIC LEVEL control to MIN by turning it counterclockwise.**
- 3. Connect a microphone (not supplied) by plugging it into the MIC 1 and/or MIC2 jack.**

#### 4. Press the KARAOKE MODE/MPX button on the Unit to select the Karaoke mode you want to use.

Each time you press the button, Karaoke mode changes as follows.

Lch MONO → Rch MONO → V.REPLACE → V.MASKING → NORMAL → (back to the beginning)

Lch MONO: Only the left channel (instrumental parts) are played through both speakers.

Rch MONO: Only the right channel (vocal parts) are played through both speakers.

V.REPLACE: Your voice replaces the right channel (vocal parts) when you sing into the microphone.

V.MASKING: This has no effect for a multiplex CD and will be used for an audio CD. (See page 22.)

NORMAL: Cancels the Karaoke mode.

- You can also select Karaoke mode during playback.

#### 5. Play a multiplex Karaoke CD.

To play a video CD with the PBC function, see page 13.

#### 6. Adjust the main volume and the MIC LEVEL control as you sing into the microphone.

- If you want to record on a tape, carry out CD Direct Recording or One Track Recording. (See page 18.)

To cancel the Karaoke mode, press the KARAOKE MODE/MPX button until "NORMAL" appears on the display.

##### Notes:

- After finishing singing along, always cancel the Karaoke mode. Karaoke mode will be also cancelled if you change the function or turn off the power.
- If "howling" occurs, keep the microphone away from the speakers.
- When digital recording is made to an external equipment through the OPTICAL DIGITAL OUT terminal using an audio CD, the microphone sound is not recorded.

### Applying Echo to Your Voice

You can apply echo to your voice through the microphone(s) except when you select the Tuner as a source.

#### Press the DIGITAL ECHO button on the Remote Control until "ECHO ON" appears on the display.

Each time you press the button, echo turns on and off, and "ECHO ON" and "ECHO OFF" appear for three seconds.

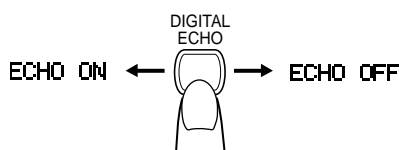

To cancel the echo, press the DIGITAL ECHO button again until "ECHO OFF" appears on the display. Selecting the Tuner or turning off the power will also cancel the echo.

**Note:** During recording, you cannot switch the echo.

### Adjusting the Music Key

During playback a CD or in Stop mode, you can adjust the music key level between -6 and +6. (0: Normal key) You can use this function for only CDs.

#### 1. Press the KEY CONTROL button on the Remote Control.

The current key level (e.g. "KEY 0") appears on the display.

#### 2. Within five seconds, press the UP or DOWN button on the Remote Control to adjust the key level.

You can adjust the key level between "KEY -6" and "KEY +6".

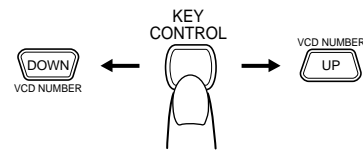

- The key setting will also appear on the TV screen in the graphical form.  
Display on the TV screen: "KEY b - - - - - h - - - - - #"

#### 3. Press the KEY CONTROL button again or wait until the key level disappears.

To return to the normal key level, repeat above steps and set the key level to "KEY 0".

##### Notes:

- You cannot adjust the music key during recording.
- Once the music key is adjusted, the key level will not return to the normal level ("KEY 0") until your reset it to "KEY 0", change the source, or turn off the power.

## Microphone Mixing

Using a microphone, you can mix the microphone sound with a source sound.

#### 1. Set MIC LEVEL control to MIN by turning it fully counterclockwise.

#### 2. Connect a microphone (not supplied) by plugging it into the MIC 1 and/or 2 jack.

#### 3. Start a source: CD, tape, tuner, or other equipment.

#### 4. Adjust the main volume and the MIC LEVEL control, as you sing into the microphone.

- You can apply echo to your voice except when you select Tuner as a source. To apply the echo, press the DIGITAL ECHO button on the Remote Control until "ECHO ON" appears on the display. To cancel the echo, press the same button again. "ECHO OFF" will appear on the display. Selecting the Tuner or turning off the power will also cancel the echo.

**Note:** If "howling" occurs, keep the microphone away from the speakers.

## To Record Microphone Mixing on a Tape

#### 1. Follow the above steps 1-4.

#### 2. To record, follow the steps in "Standard Recording". (See page 17.)

**Note:** When digital recording is made to an external equipment through the OPTICAL DIGITAL OUT terminal using an audio CD, the microphone sound is not recorded.

# Care And Maintenance

Handle your CDs carefully, and they will last a long time.

## Compact Discs

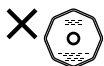

- Only CDs bearing this mark can be used with this System. However, continued use of irregularly shaped CDs (heart-shape, octagonal, etc.) can damage the System.



- Remove the CD from its case by holding it at the edges while pressing the case's center hole lightly.
- Do not touch the shiny surface of the CD, or bend the CD.

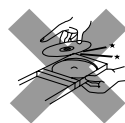

- Put the CD back in its case after use to prevent warping.
- Be careful not to scratch the surface of the CD when placing it back in the case.
- Avoid exposure to direct sunlight, temperature extremes, and moisture.



- A dirty CD may not play correctly. If a CD does become dirty, wipe it with a soft cloth in a straight line from center to edge.

**CAUTION: Do not use any solvent (for example, conventional record cleaner, spray thinner, benzene, etc.) to clean a CD.**

## General Notes

In general, you will have the best performance by keeping your CDs and the mechanism clean.

- Store CDs in their cases, and keep them in cabinets or on shelves.
- Keep the system's CD cover closed when not in use.

## Cleaning the lens

If the lens in the CD pickup is dirty, dropout, etc., could degrade sound.

Open the CD cover and clean the lens as shown.

- Use a blower (available from a camera store) to blow dust off the lens.

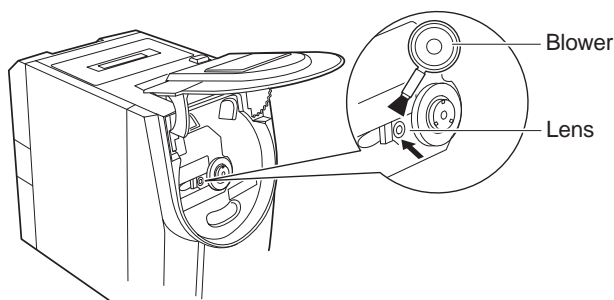

- If there are fingerprints, etc. on the lens, gently wipe clean with a cotton swab.

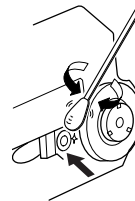

## Moisture Condensation

Moisture may condense on the lens inside the System in the following cases:

- After turning on heating in the room.
- In a damp room.
- If the System is brought directly from a cold to a warm place.

Should this occur, the System may malfunction. In this case, leave the System turned on for a few hours until the moisture evaporates, unplug the AC power cord, and then plug it in again.



## Cassette Tapes

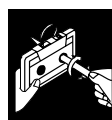

- If the tape is loose, it may get stretched, cut, or caught in the cassette. Take up the slack by inserting a pencil in one of the reels and rotating.



- Do not touch the tape surface.



- Do not store the tape:
  - In dusty places
  - In direct sunlight or heat
  - In moist areas
  - On a TV or speaker
  - Near a magnet

## Cassette Deck

- If the heads, capstans, or pinch-rollers of the Cassette Deck become dirty, the following may occur:
  - Loss of sound quality
  - Discontinuous sound
  - Fading
  - Incomplete erasure
  - Difficulty recording
- Clean the heads, capstans, and pinch-rollers using a cotton swab moistened with alcohol.

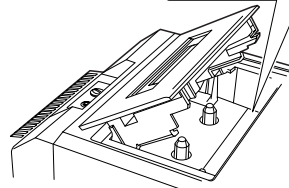
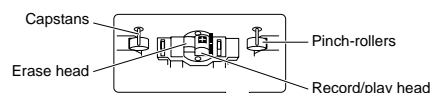

- If the heads become magnetized, the Unit will produce noise or lose high frequency notes.
- To demagnetize the heads, turn off the Unit, and use a head demagnetizer (available at electronics and record shops).

# Troubleshooting

- If you are having a problem with your System, check this list for a possible solution before calling for service.
- If you cannot solve the problem from the hints given here, or the System is damaged, call a qualified person, such as your dealer, for service.

Symptom	Possible Cause	Action
You cannot hear any sound.	<ul style="list-style-type: none"> <li>• Connections are incorrect, or loose.</li> <li>• Headphones are connected.</li> </ul>	<ul style="list-style-type: none"> <li>• Check all connections and make corrections. (See pages 3-5.)</li> <li>• Disconnect the headphones.</li> </ul>
You are unable to record.	Cassette record protect tabs are removed.	Cover the holes on the back edge of the cassette with tape.
The radio reception is poor.	<ul style="list-style-type: none"> <li>• The antenna is disconnected.</li> <li>• The AM/SW Loop Antenna is too close to the System.</li> <li>• The FM/SW Wire Antenna is not properly extended and positioned.</li> </ul>	<ul style="list-style-type: none"> <li>• Reconnect the antenna securely.</li> <li>• Change the position and direction of the AM/SW Loop Antenna.</li> <li>• Extend the FM/SW Wire Antenna to the best reception position.</li> </ul>
The CD skips.	The CD is dirty or scratched.	Clean or replace the CD.
The CD does not play.	The CD is upside down.	Put the CD in with the label side up.
You are unable to operate the Remote Control.	<ul style="list-style-type: none"> <li>• The path between the Remote Control and the sensor on the Unit is blocked.</li> <li>• The batteries have lost their charge.</li> </ul>	<ul style="list-style-type: none"> <li>• Remove the obstruction.</li> <li>• Replace the batteries.</li> </ul>
The cassette holder cannot be opened.	During tape playing, the power cord was unplugged.	Plug in the power cord, press the $\odot$ /I button, and then press the $\blacktriangle$ button.
The image on the TV screen is distorted.	VIDEO OUT select is not matching.	Select the correct TV system. (See pages 4 and 12.)
The disc sound losses stereo effect or lead vocal is not heard.	The MPX Sound, Vocal Masking, or Vocal Replace function is in use.	Press the KARAOKE MODE/MPX button on the Unit until "NORMAL" appears on the display.
The picture of the video CD or CD-G is distorted.	When you pause or skip the track, the pictures will be distorted. This is not a malfunction.	
All functions do not operate.	The built-in microprocessor has malfunctioned due to an external electrical interference.	Unplug the System, then plug it back in.

# Specifications

## Amplifier

Output Power	34 W (17 W + 17 W) at 4 ohms (Max.)
Input Sensitivity/Impedance (1 kHz)	
LINE IN (AUX)	500 mV/65 kohms
MIC1/MIC2	200 ohms - 2 kohms
Output Sensitivity/Impedance (1 kHz)	
LINE OUT	500 mV/4.3 kohms
Optical out	-21 dBm - -15 dBm
Speaker terminals	4 - 16 ohms
Phones	16 ohms - 1 kohm
	0 - 15 mW/ch output into 32 ohms
Video Out (composite)	1.0 Vp - p (75 ohms)

## Cassette Deck

Frequency Response	
TypeII (CrO <sub>2</sub> )	50 Hz - 15 kHz
Wow and Flutter	0.15 % (WRMS)

## CD Player

Signal-To-Noise Ratio	95 dB
Wow And Flutter	Unmeasurable
Playback Disc	Video CD (with/without Playback Control function), CD Graphics, Audio CD

## Tuner

FM Tuner	
Tuning Range	87.5 - 108.0 MHz
AM Tuner	
Tuning Range	531 - 1,710 kHz (except for Saudi Arabia) 531 - 1,602 kHz (for Saudi Arabia only) (at 9 kHz channel space)
	530 - 1,710 kHz (except for Saudi Arabia) 530 - 1,600 kHz (for Saudi Arabia only) (at 10 kHz channel space)
SW Tuner	
Tuning Range	2.3 - 21.85 MHz

## Speaker Specifications

(each unit)	
Type	1-way bass-reflex type (Magnetically-Shielded Type)
Speakers	8 cm cone
Impedance	4 ohms
Dimensions	140 mm × 230 mm × 217 mm (W/H/D)
Mass	Approx. 1.8 kg

## General

Dimensions	438 mm × 232 mm × 310.5 mm (W/H/D)
Mass	Approx. 7.4 kg

## Accessories

Power Cord (1)
AM/SW Loop Antenna (1)
FM/SW Wire Antenna (1)
Video Cord (1)
Remote Control (1)
Batteries R6P (SUM-3)/AA (15F) (2)
AC Plug Adaptor (except for Hong Kong) (1)

## Power Specifications

Power Requirements	AC 110 V/127 V/230 V ~ , adjustable with the voltage selector, 50 Hz/60 Hz
Power Consumption	42 watts (power on mode) 3 watts (in Standby mode)

*Design and specifications are subject to change without notice.*

## Mains (AC) Line Instruction (not applicable for Europe, U.S.A., Canada, Australia, and U.K.)

主 (AC) 电源线路说明 (不适用于欧洲美国加拿大澳洲及英国型号)

تعليمات خط التيار الكهربائي الرئيسي (المتردد) (لا تنطبق على أوروبا والولايات المتحدة الأمريكية وكندا وأستراليا والمملكة المتحدة)

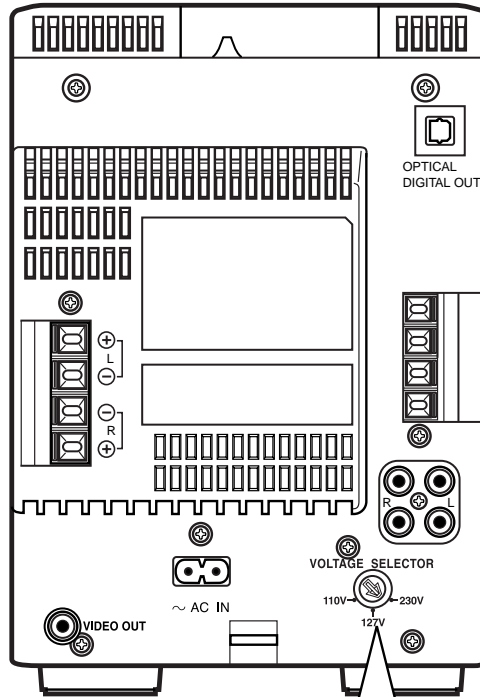

### IMPORTANT for mains (AC) line

BEFORE PLUGGING IN, do check that your mains (AC) line voltage corresponds with the position of the voltage selector switch provided on the outside of this equipment and, if different, reset the voltage selector switch, to prevent from a damage or risk of fire/electric shock.

有关主 (AC) 电源线路的重要事项  
接插电源以前，务请检查当地的主 (AC) 电源线路电压是否位于本机外面的电压选择开关设定的位置一致。如果不一致，即重新设定电压选择开关使其符合当地电压，以免损坏机器或引起火灾/触电的危险。

### VOLTAGE SELECTOR

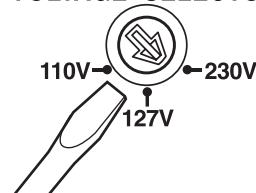

### هام من أجل خط التيار الكهربائي الرئيسي (المتردد)

قبل إدخال قابس الطاقة الكهربائية، تحقق من مطابقة مفتاح اختيار فولطية التيار الكهربائي الرئيسي (المتردد) الموجود على خلفية الجهاز مع فولطية التيار الكهربائي المحلية. إذا كان مختلفاً، أعد ضبط مفتاح اختيار الفولطية على قيمة التيار الكهربائي المتردد المحلية تفادياً لإتلاف الجهاز أو التعرض لمخاطر الحريق/الصدمة الكهربائية.